

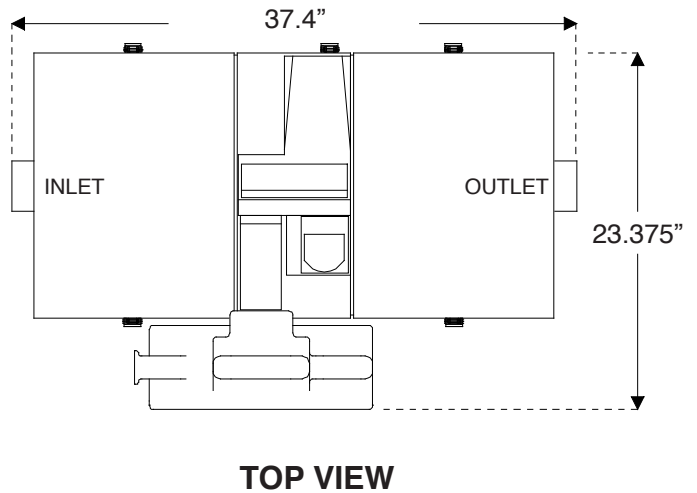

Big Dipper® IS Point Source Automatic Grease Removal Systems

W-350-IS Specifications

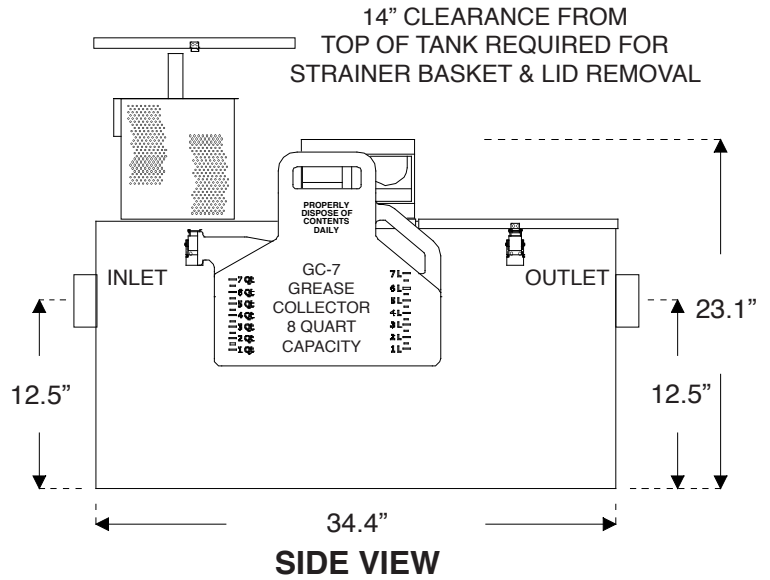
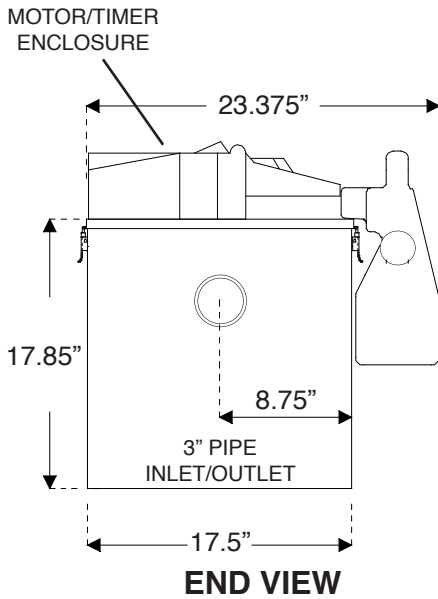

FEATURES:

- Fully automatic self cleaning cycle. Removes collected grease & oils from tank without any operator assistance. Comes complete with 24-hour timer and Grease Collector.
- Constructed of corrosion resistant materials suitable for installation in virtually any location. Attractive sanitary Stainless Steel exterior.
- Integrated Motor/Grease Outlet/Heater/Lid enables a fast, do-it-yourself unit operation reversal.
- Compact footprint.
- Two (2) No-Hub Connectors provided.

TECHNICAL DATA

Materials:	Exterior: 304 Stainless Steel, Bright Finish
	Interior: Rotationally Molded Polyethylene
Electrical:	115 VAC, 60 Hz, 520 Watts (4.5 Amps)
Maximum Inlet Flow Rate:	35 GPM
Number of Skimming Wheels:	1
Skimming Rate:	20 Pounds Per Hour
Grease Retention Capacity:	70+ Pounds
Internal Solids Strainer Capacity:	2.5 Gallons



©2007 Thermaco, Inc. • All rights reserved • Patented/Patents Pending • Specifications subject to change without notice



Big Dipper® IS Point Source Automatic Grease Removal Systems

W-350-IS Specifications

INSTALLATION INFORMATION

Suggested Minimum Footprint Dimensions

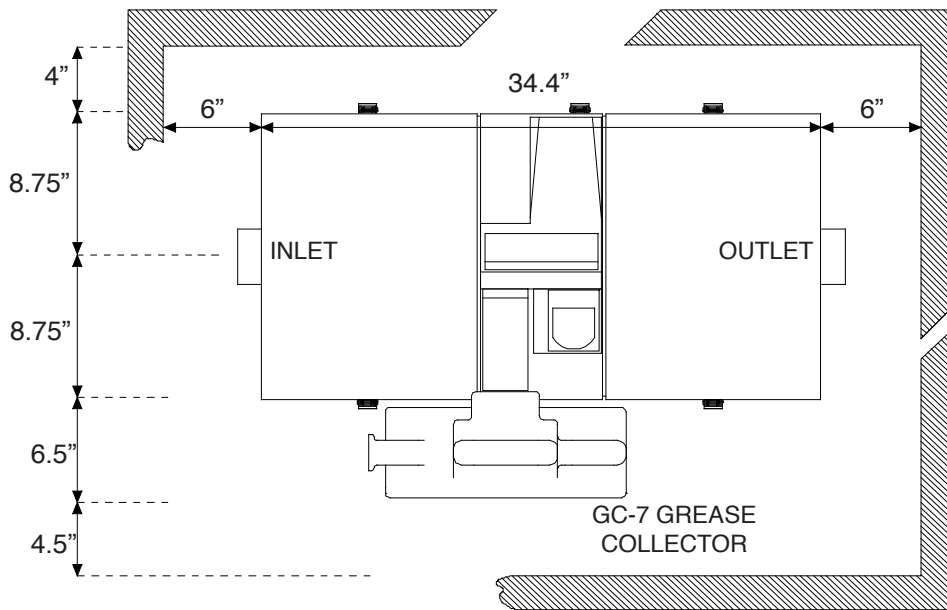

DO . . .

Allow a minimum of 14" clearance from top of tank for removal of unit lid.

READ instruction manual included with system before doing anything.

Install unit allowing for the minimum clearances shown.

Make sure the height above the Internal Strainer Access Cover is enough to remove the strainer.

Make piping connections with rubber "No Hub" connectors (provided).

Keep outlet piping as straight as possible. Use only "sweep" connections.

Install vent on outlet piping.

Fill the tank with water before energizing the power to the motor and heater.

Set Programmable Time Controller for proper operating times.

DON'T . . .

Install "P" trap on outlet connection of tank. (Note: the unit already has an internal gas trap).

Reduce pipe size on outlet piping.

NOTE: Drawing for reference only. Equipment must be installed in compliance with all applicable laws, regulations and codes, including plumbing codes. Installation should be performed by a qualified plumber.

Job Specification:

Grease and oils separator(s) shall be Thermaco **Big Dipper** automatic grease/oil recovery system(s) as manufactured by Thermaco, Inc., Asheboro, North Carolina as noted on plans.

Separator Specifications:

Furnish and install ___ Thermaco **Big Dipper** Model No. W-350-IS, bright finish type 304 stainless steel exterior, rotationally molded polyethylene interior automatic self-cleaning grease and oil recovery separator(s) for floor mounted or partially recessed installation, rated at 35 gallons per minute peak flow, 70 pounds of grease capacity and including as an integral part of the unit, 1 rotating gear hydrophobic wheel assembly for automatic grease/oil removal, an integral flow control device, self-regulating enclosed electric immersion heater, a vessel vent, an integral gas trap, an integral programmable 24-hour multi-event time control, a field reversible motor location, a field reversible grease/oil sump outlet, quick release stainless steel lid clamps, a gasketed and fully removable 304 stainless steel lid, a lift-out strainer basket access, an internal stainless steel strainer basket for collection of coarse solids, and a separate grease and oils collection container. Electric assembly shall be tested to comply with pertinent sections of the Standards for Safety ANSI/UL 73 and/or ANSI/UL 1004. Electric motor equipped with overload protection. Two (2) no-hub connectors for plumbing connection provided.